

Female Header 2.54 mm

180° Series

SPECIFICATIONS

Current Rating: 3 A
 Insulator Resistance: 5000 MOhm min.
 Contact Resistance: 20 mOhm max.
 Dielectric Withstanding: AC 1000 V
 Operating Temperature: -40°C ~ +105°C
 Soldering Temperature: 260°C for 3~5 sec. max
 Contact Material: Phosphor Bronze
 Insulator Material: Polyester, UL 94V-0
 Standard: P.B.T.
 Finish: Tin, Gold or Duplex Plated
 Standard: Gold Flash all over
 Note: Duplex Plating: Gold Plated on contact area, Tin on solder area

F044-SGP-D030-XX

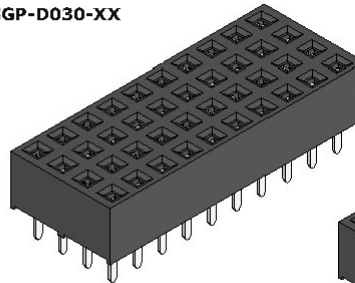

F034-SGP-D030-XX

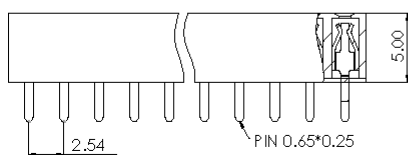
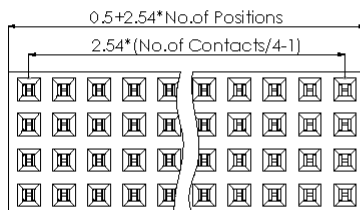
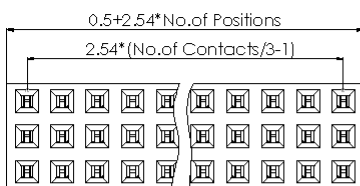
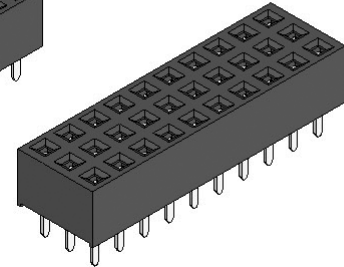

[F034]

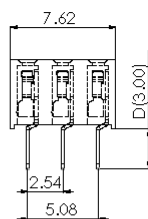

[F044]

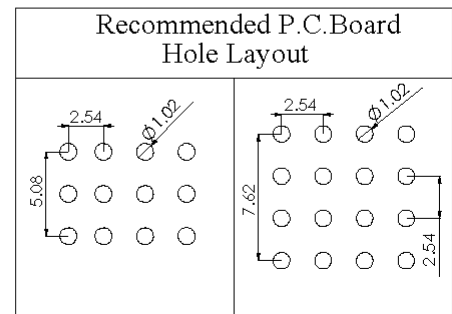
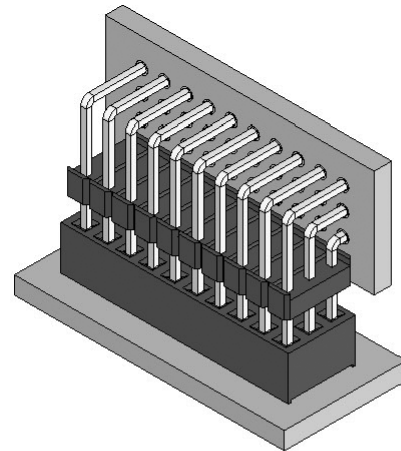
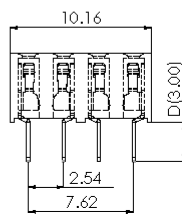

How to order

Unit: mm

Series	Connector Type	Contact Plating	Material	Pin Length mm	Number of Contacts
FXXX	X	X	X	DXXX	XXX
F034:F/H 2.54 H:5.00 triple Row F044:F/H 2.54 H:5.00 quadruple Row	S: Straight Type	G: Gold Flash T: Tin Plated A: 10U" Gold B: 15U" Gold C: 20U" Gold © Duplex Plating D: Gold Flash/Tin (Standard: G)	P: PBT N: Nylon-6T (Standard: P)	S-D D030	F034: (09 TO 96 Contacts) F044: (16 TO 120 Contacts)